

# amorim

*Sistemas em alumínio*

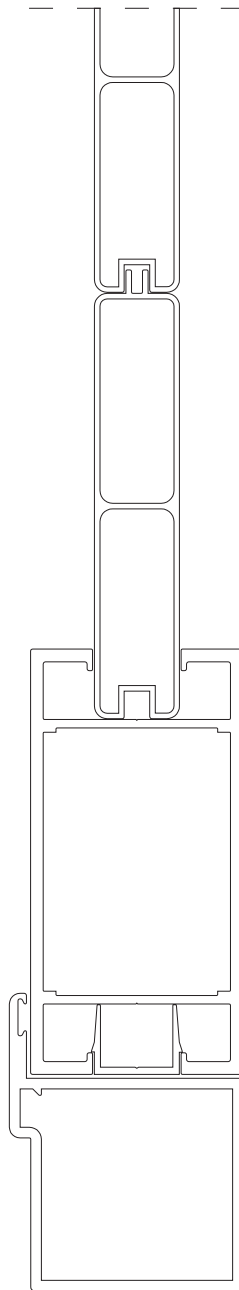

## SÉRIE PORTÕES



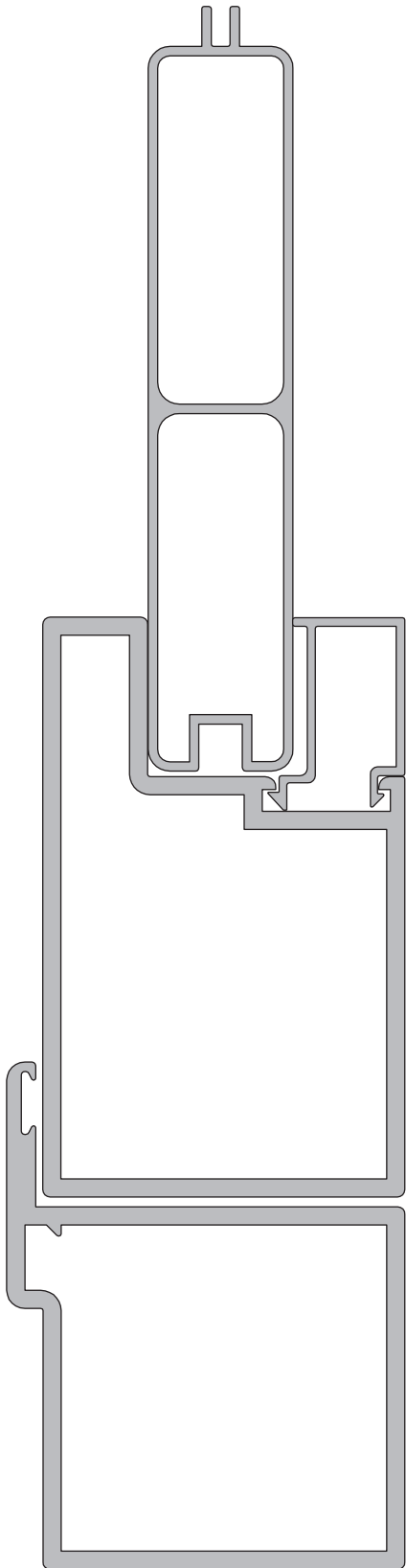



## SÉRIE PT

É um sistema de portões de soldar ou aparafusar com aro de largura 50mm que permite várias soluções construtivas para o mercado habitacional obtendo uma boa relação qualidade/preço.

Adequado para as seguintes tipologias:

- Portão de abrir de 1 ou 2 folhas
- Portão de correr
- Gradeamento de muro

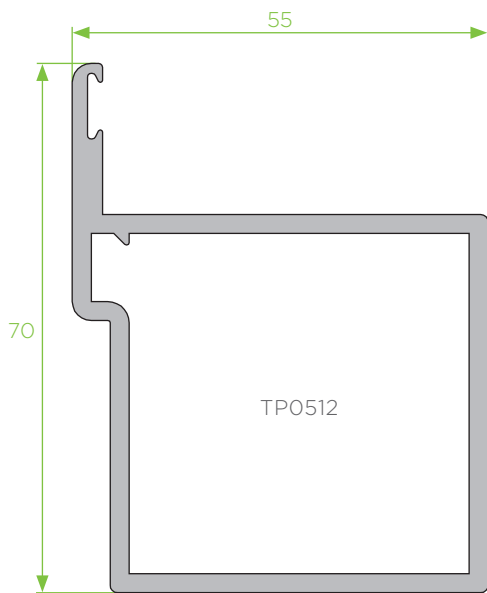

**PT - 01**  
aro fixo

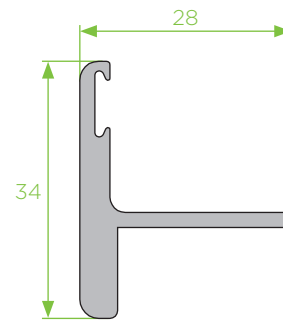

**PT - 02**  
remate batente

PT

206

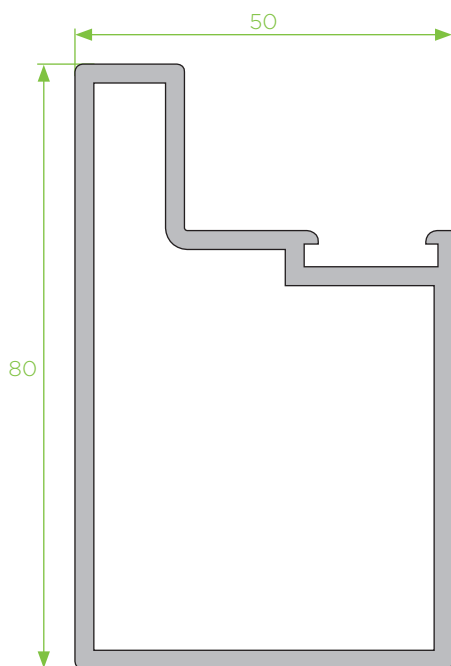

**PT - 03**  
folha móvel

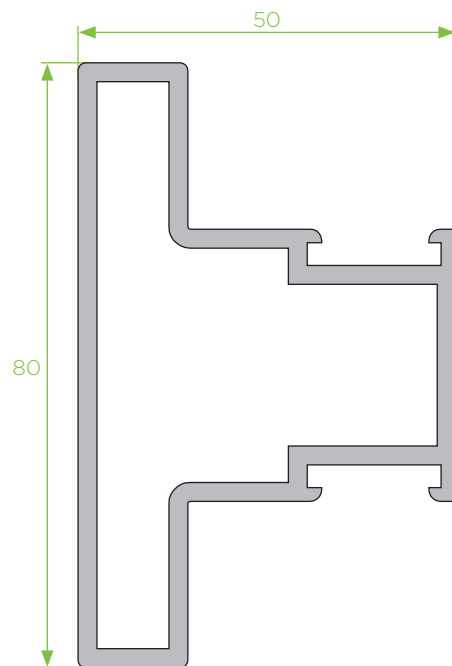

**PT - 04**  
travessa

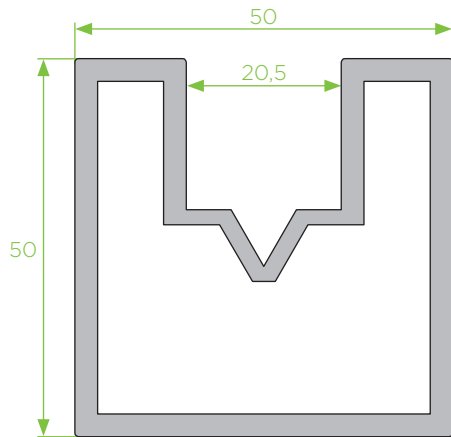

**PT - 07**  
folha móvel

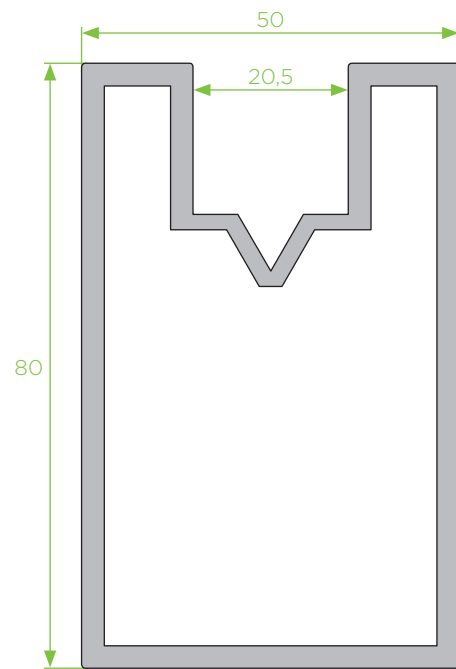

**PT - 09**  
folha móvel

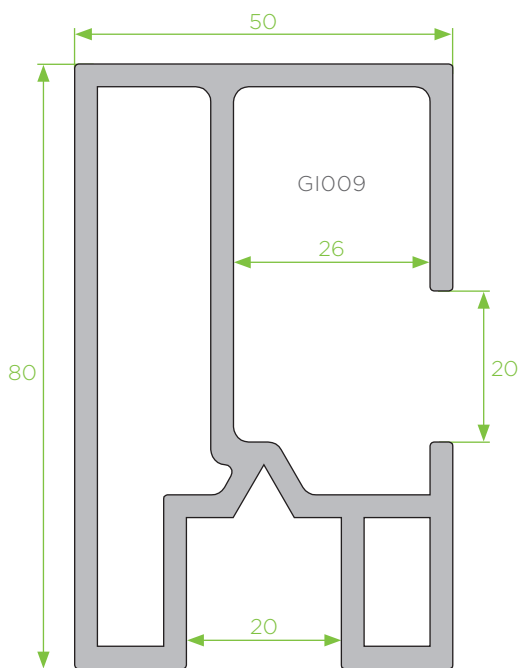

**PT - 10**  
folha móvel

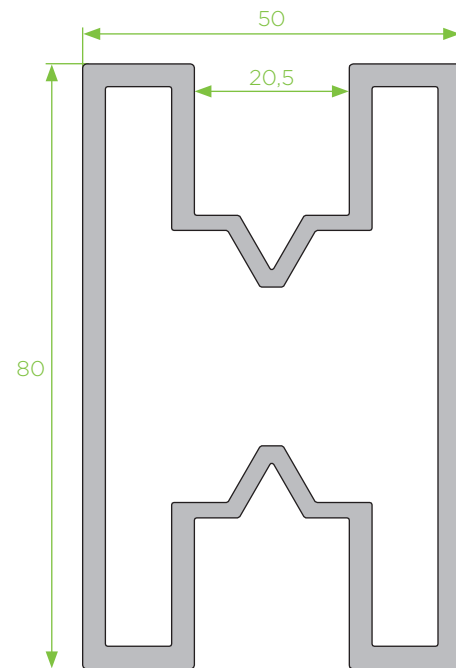

**PT - 29**  
travessa

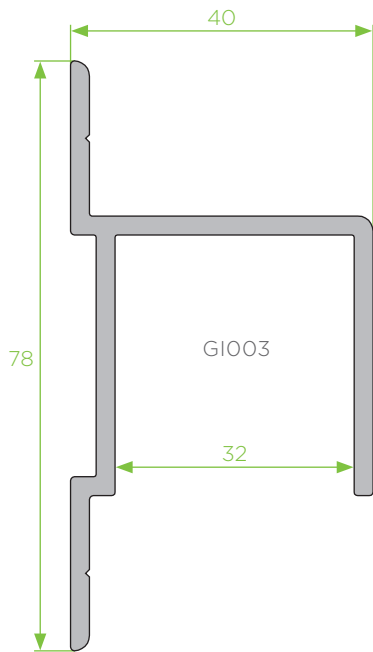

**PT - 21**  
calha para guia correr

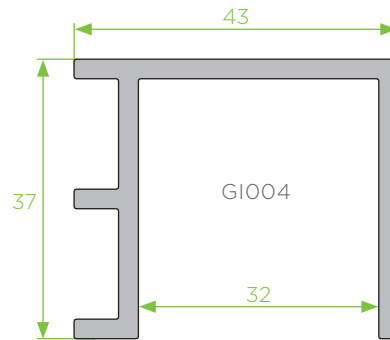

**PT - 05**  
calha para guia correr

PT

208

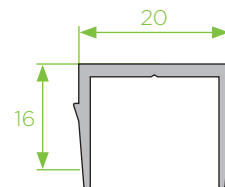

**PT - 38**  
tapa junta

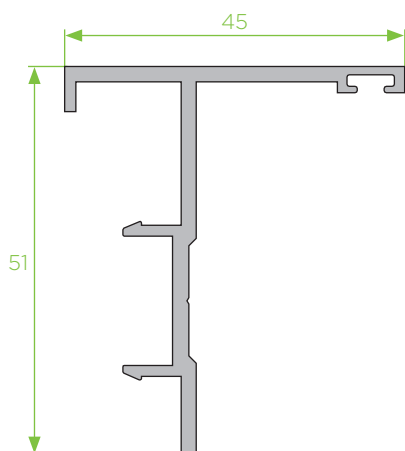

**PT - 34**  
batente

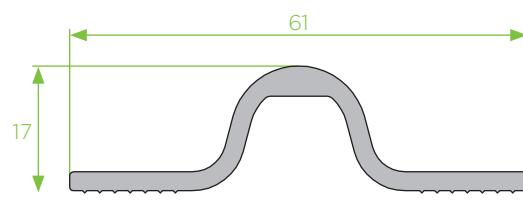

**PT - 23**  
rail portão correr

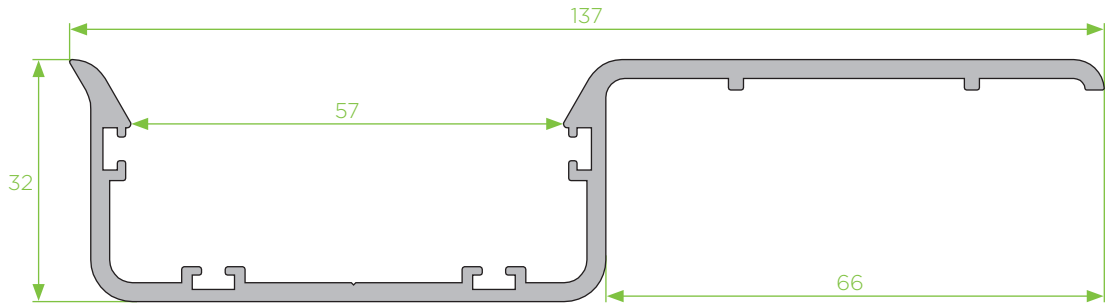

**PT - 08**  
batente lateral correr

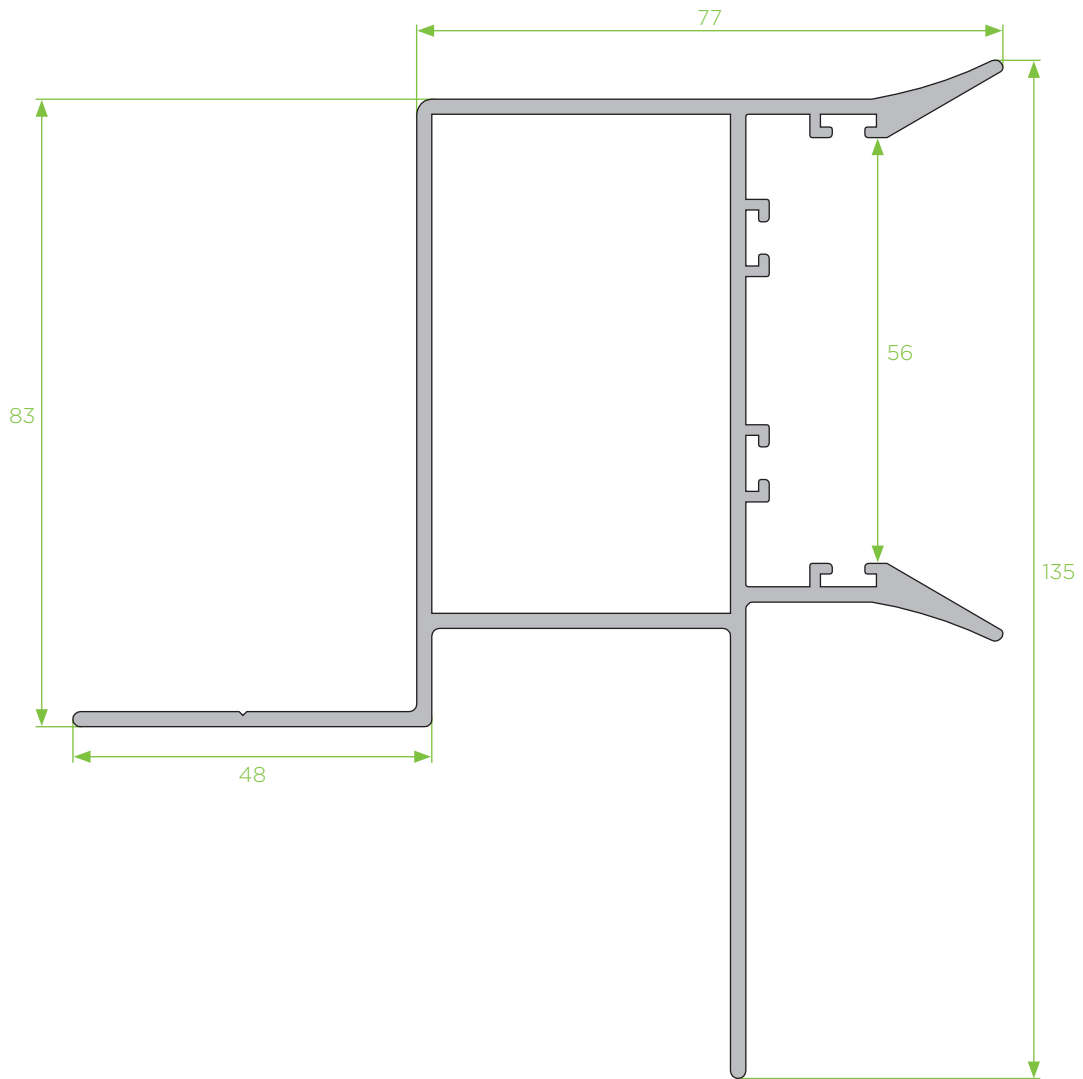

**PT - 20**  
batente lateral correr

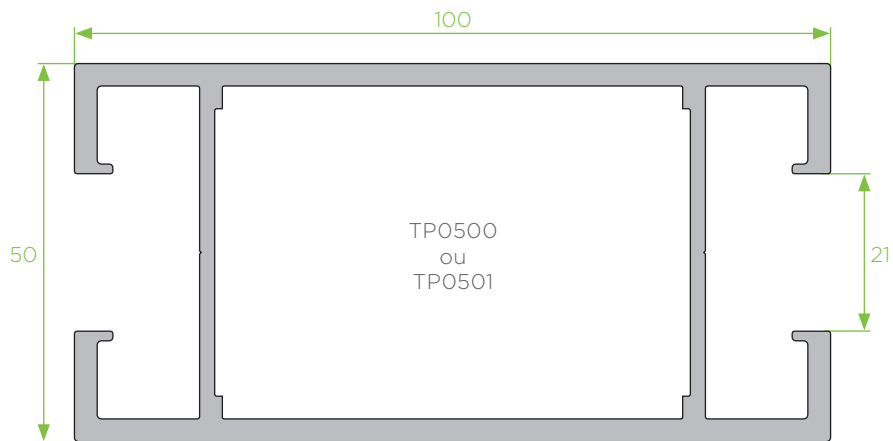

**PT - 31**  
prumo vertical

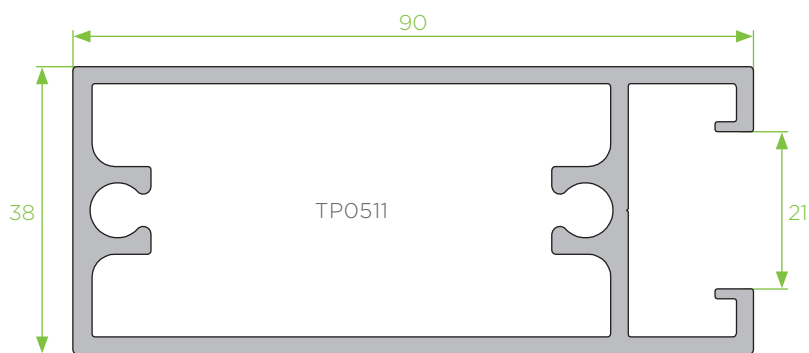

**PT - 32**  
travessa superior/inferior

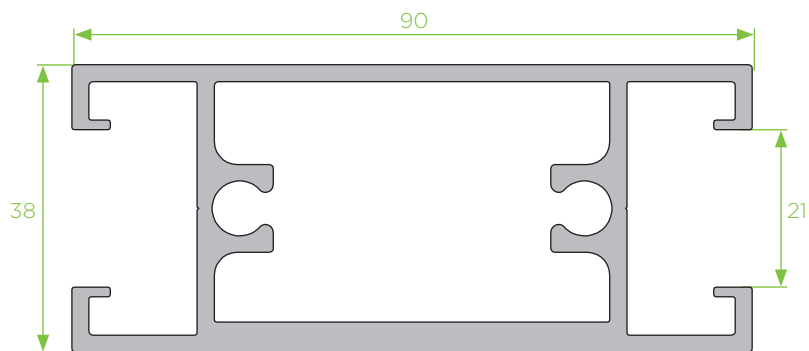

**PT - 33**  
travessa central

PT

210



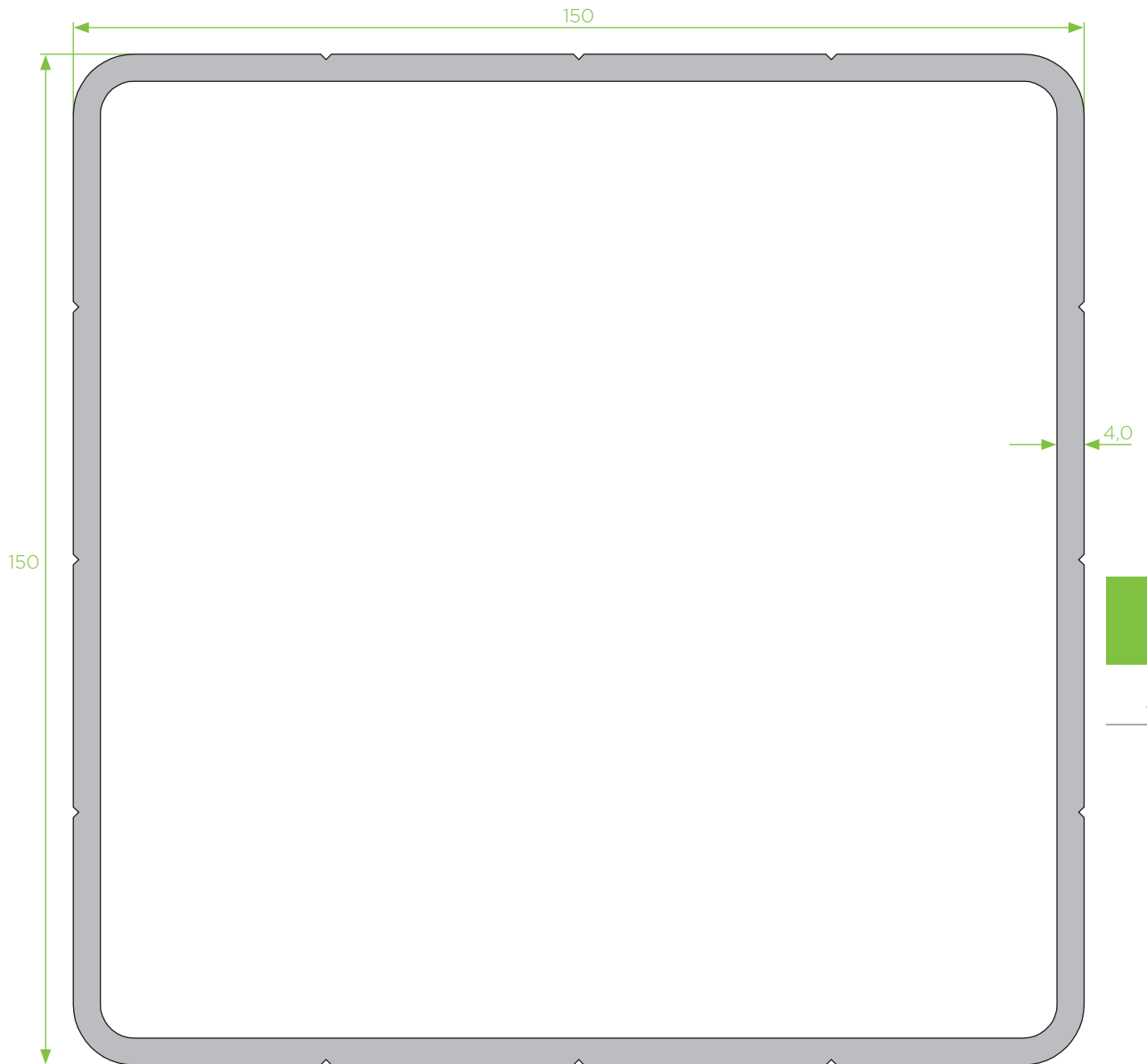

PT

211

**PT - 25**

perfil poste 150x150x4

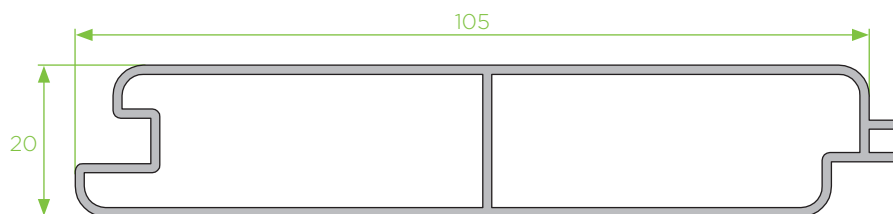

**P - 44**

chapa régua dupla

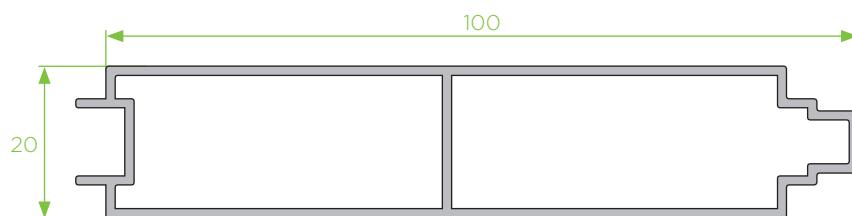

**P - 53**

chapa régua dupla

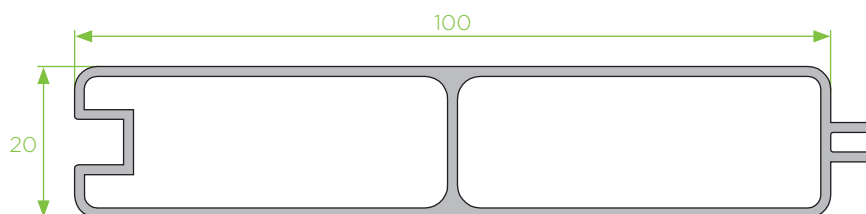

**P - 74**

chapa régua dupla

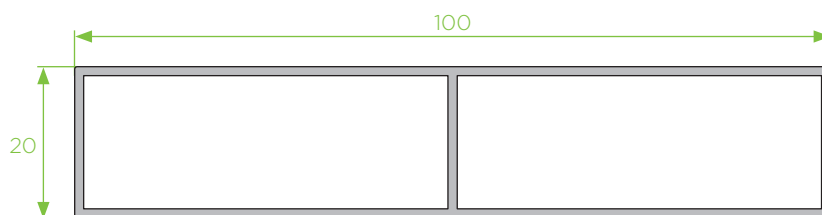

**P - 30**

régua 100x20x1,3

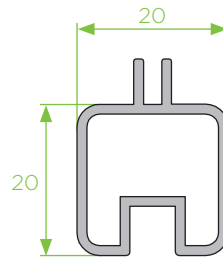

**P - 71**  
régua de ligação

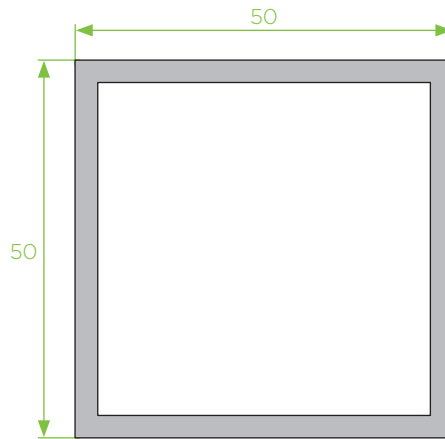

**PT - 50**  
tubo quadrado (50x50x3,0)

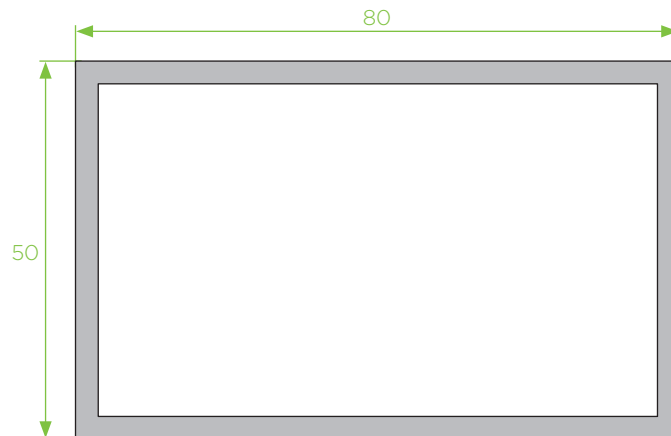

**80x50x3,0**  
tubo retangular

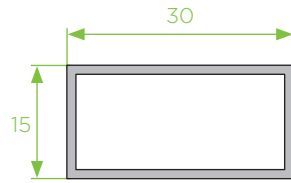

**30x15x1,2**  
tubo de ligação

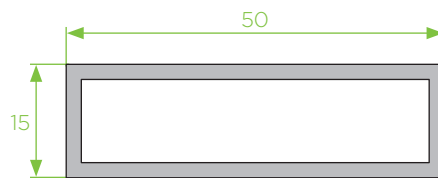

**50x15x2,0**  
tubo de ligação

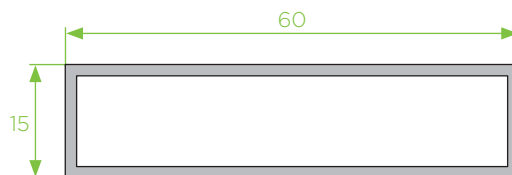

**60x15x1,5**  
tubo de ligação

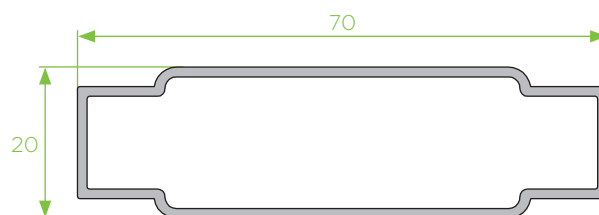

**P - 70**  
régua de ligação

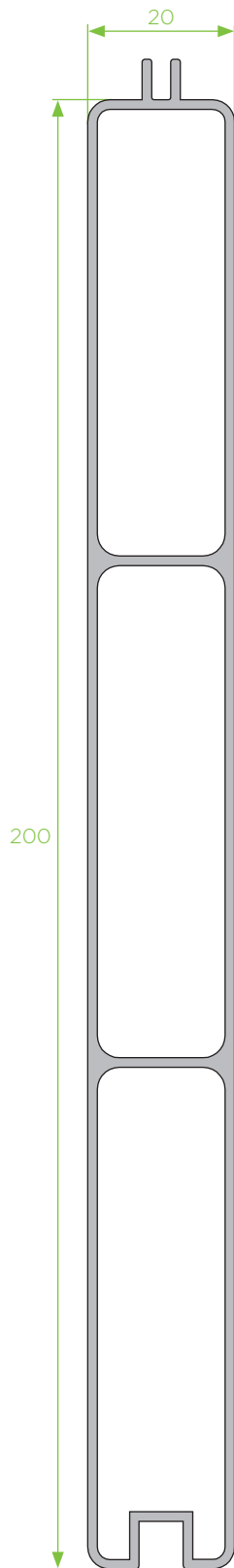

**P - 66**

chapa régua tripla

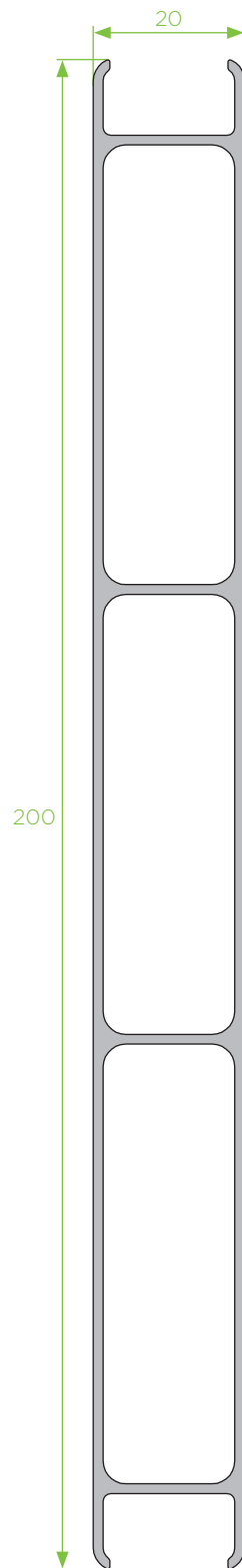

**P - 68**

chapa régua tripla

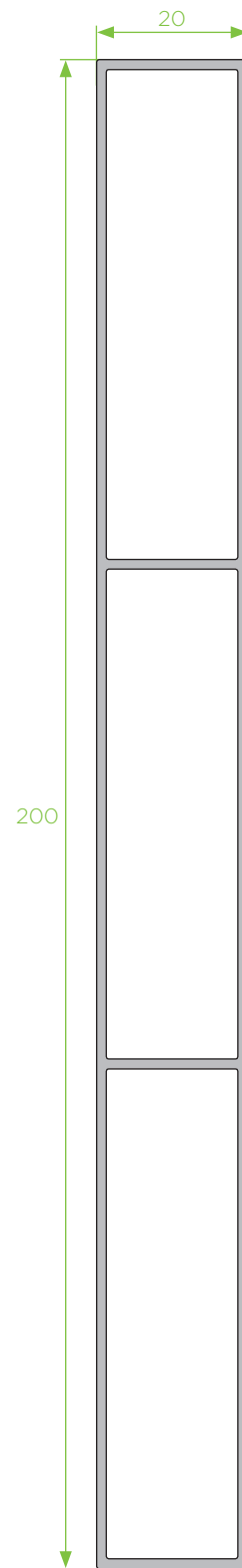

**P - 72**

chapa régua tripla

PT

216

30x15

10

50x15

30

60x15

40

P - 70

50

**P - 68**

escala 1 : 2

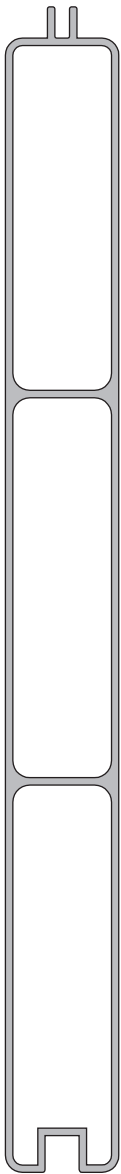
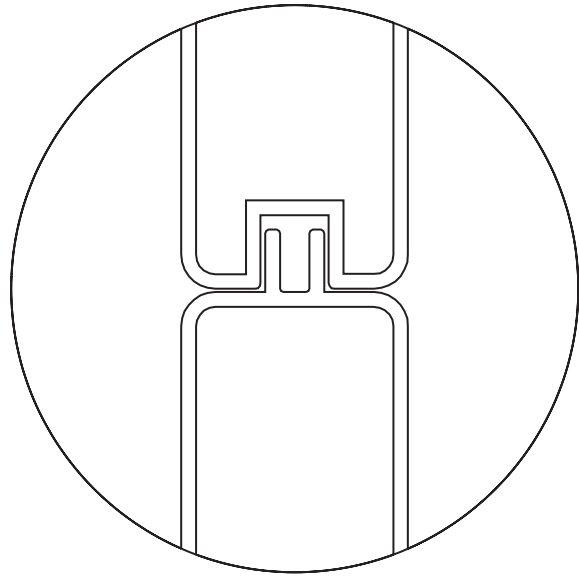

P - 66

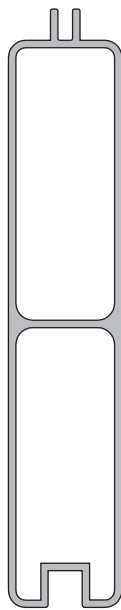

P - 74

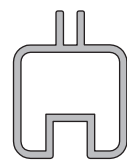

P - 71